

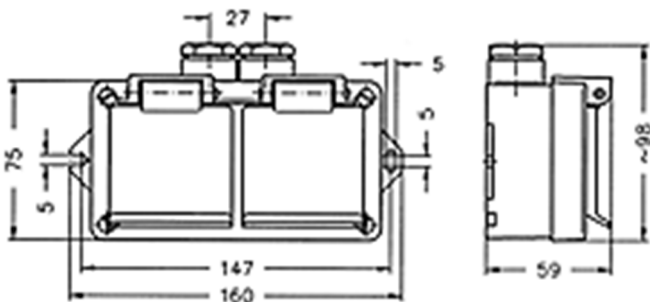















**DUAL SOCKET OUTLET 16 A, 250 V, IP 44**

 Model no: **516 101 - 513 301**

- The springs of the hinged covers are of stainless steel.
- Aluminum cable gland seals PG 16, cable Ø 11mm.
- Box IK08
- Grey: 24 019 51-53, RAL-7035, QN-quality
- Brown: 24 019 61-63
- The RAL-7035 color series products meet the highest UV protection and corrosion requirements. All 7035 products are with acid-resistant cover screws and oil-resistant gaskets.
- Country Of Origin = Finland
- Available also as single socket or as IP67/68 version
- Foreign versions as NEMA, BR, DK and so on. USB possibility.
- CE certification according to IEC 60884-1
- 3D CAD files



			Model	Order no.	Marine model	Socket
		0,51	516 101 EM	<a href="#">24 019 51</a>	Yes	SCHUKO
		0,53	516 301 EM	<a href="#">24 019 53</a>	Yes	SCHUKO
		0,53	516 201 EM	<a href="#">24 019 52</a>	Yes	SCHUKO
		0,51	516 101	<a href="#">24 019 61</a>	7229221	SCHUKO
		0,53	516 201	<a href="#">24 019 62</a>	7229222	SCHUKO
		0,53	516 301	<a href="#">24 019 63</a>	7229229	SCHUKO

**Selcast Oy**

 Kilantie 19 (BOX 36)  
 10300 KARJAA (10301 KARJAA)  
 FINLAND

+358 19 278 5800

[www.selcast.fi](http://www.selcast.fi) [selcast@selcast.fi](mailto:selcast@selcast.fi)